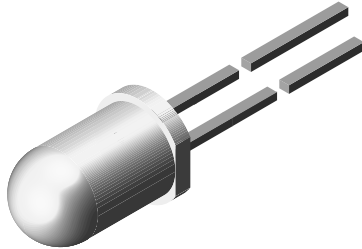


## High Power Infrared Emitting Diode, RoHS Compliant, 940 nm, GaAlAs/GaAs



94 8389

**DESCRIPTION**

TSAL7600 is an infrared, 940 nm emitting diode in GaAlAs/GaAs technology with high radiant power molded in a clear, untinted plastic package.

**FEATURES**

- Package type: leaded
- Package form: T-1 $\frac{3}{4}$
- Dimensions (in mm):  $\varnothing$  5
- Peak wavelength:  $\lambda_p = 940$  nm
- High reliability
- High radiant power
- High radiant intensity
- Angle of half intensity:  $\varphi = \pm 30^\circ$
- Low forward voltage
- Suitable for high pulse current operation
- Good spectral matching with Si photodetectors
- Lead (Pb)-free component in accordance with RoHS 2002/95/EC and WEEE 2002/96/EC


**RoHS**  
COMPLIANT

**APPLICATIONS**

- Infrared remote control units with high power requirements
- Free air transmission systems
- Infrared source for optical counters and card readers

**PRODUCT SUMMARY**

| COMPONENT | $I_e$ (mW/sr) | $\varphi$ (deg) | $\lambda_p$ (nm) | $t_r$ (ns) |
|-----------|---------------|-----------------|------------------|------------|
| TSAL7600  | 25            | $\pm 30$        | 940              | 800        |

**Note**

Test conditions see table "Basic Characteristics"

**ORDERING INFORMATION**

| ORDERING CODE | PACKAGING | REMARKS                      | PACKAGE FORM      |
|---------------|-----------|------------------------------|-------------------|
| TSAL7600      | Bulk      | MOQ: 4000 pcs, 4000 pcs/bulk | T-1 $\frac{3}{4}$ |

**Note**

MOQ: minimum order quantity

**ABSOLUTE MAXIMUM RATINGS**

| PARAMETER                           | TEST CONDITION                        | SYMBOL     | VALUE         | UNIT       |
|-------------------------------------|---------------------------------------|------------|---------------|------------|
| Reverse voltage                     |                                       | $V_R$      | 5             | V          |
| Forward current                     |                                       | $I_F$      | 100           | mA         |
| Peak forward current                | $t_p/T = 0.5, t_p = 100 \mu s$        | $I_{FM}$   | 200           | mA         |
| Surge forward current               | $t_p = 100 \mu s$                     | $I_{FSM}$  | 1.5           | A          |
| Power dissipation                   |                                       | $P_V$      | 160           | mW         |
| Junction temperature                |                                       | $T_j$      | 100           | $^\circ C$ |
| Operating temperature range         |                                       | $T_{amb}$  | - 40 to + 85  | $^\circ C$ |
| Storage temperature range           |                                       | $T_{stg}$  | - 40 to + 100 | $^\circ C$ |
| Soldering temperature               | $t \leq 5$ s, 2 mm from case          | $T_{sd}$   | 260           | $^\circ C$ |
| Thermal resistance junction/ambient | J-STD-051, leads 7 mm soldered on PCB | $R_{thJA}$ | 230           | K/W        |

**Note**

$T_{amb} = 25$   $^\circ C$ , unless otherwise specified

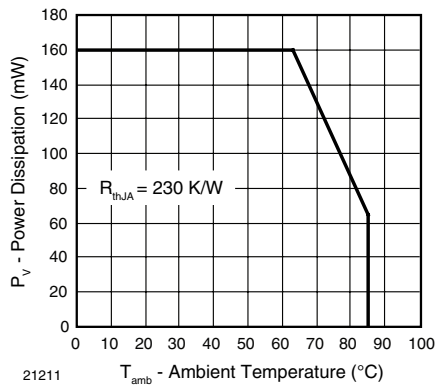


Fig. 1 - Power Dissipation Limit vs. Ambient Temperature

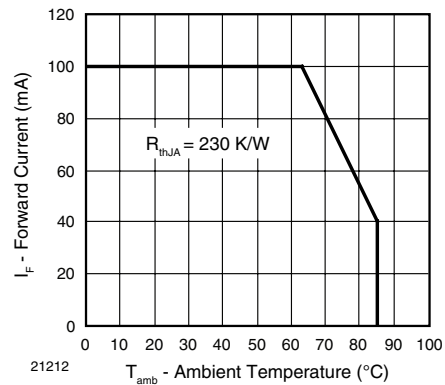


Fig. 2 - Forward Current Limit vs. Ambient Temperature

| BASIC CHARACTERISTICS                     |   |                             |      |       |      |       |
|---|---|-----------------------------|------|-------|------|-------|
| PARAMETER                                 | TEST CONDITION                                  | SYMBOL                      | MIN. | TYP.  | MAX. | UNIT  |
| Forward voltage                           | I <sub>F</sub> = 100 mA, t <sub>p</sub> = 20 ms | V <sub>F</sub>              |      | 1.35  | 1.6  | V     |
|   | I <sub>F</sub> = 1 A, t <sub>p</sub> = 100 μs   | V <sub>F</sub>              |      | 2.6   | 3    | V     |
| Temperature coefficient of V <sub>F</sub> | I <sub>F</sub> = 1 mA                           | TK <sub>V<sub>F</sub></sub> |      | - 1.8 |      | mV/K  |
| Reverse current                           | V <sub>R</sub> = 5 V                            | I <sub>R</sub>              |      |       | 10   | μA    |
| Junction capacitance                      | V <sub>R</sub> = 0 V, f = 1 MHz, E = 0          | C <sub>j</sub>              |      | 25    |      | pF    |
| Radiant intensity                         | I <sub>F</sub> = 100 mA, t <sub>p</sub> = 20 ms | I <sub>e</sub>              | 15   | 25    | 75   | mW/sr |
|   | I <sub>F</sub> = 1 A, t <sub>p</sub> = 100 μs   | I <sub>e</sub>              | 120  | 200   |      | mW/sr |
| Radiant power                             | I <sub>F</sub> = 100 mA, t <sub>p</sub> = 20 ms | φ <sub>e</sub>              |      | 35    |      | mW    |
| Temperature coefficient of φ <sub>e</sub> | I <sub>F</sub> = 20 mA                          | TKφ <sub>e</sub>            |      | - 0.6 |      | %/K   |
| Angle of half intensity                   |   | φ                           |      | ± 30  |      | deg   |
| Peak wavelength                           | I <sub>F</sub> = 100 mA                         | λ <sub>p</sub>              |      | 940   |      | nm    |
| Spectral bandwidth                        | I <sub>F</sub> = 100 mA                         | Δλ                          |      | 50    |      | nm    |
| Temperature coefficient of λ <sub>p</sub> | I <sub>F</sub> = 100 mA                         | TKλ <sub>p</sub>            |      | 0.2   |      | nm/K  |
| Rise time                                 | I <sub>F</sub> = 100 mA                         | t <sub>r</sub>              |      | 800   |      | ns    |
| Fall time                                 | I <sub>F</sub> = 100 mA                         | t <sub>f</sub>              |      | 800   |      | ns    |
| Virtual source diameter                   |   | d                           |      | 1.8   |      | mm    |

**Note**

T<sub>amb</sub> = 25 °C, unless otherwise specified

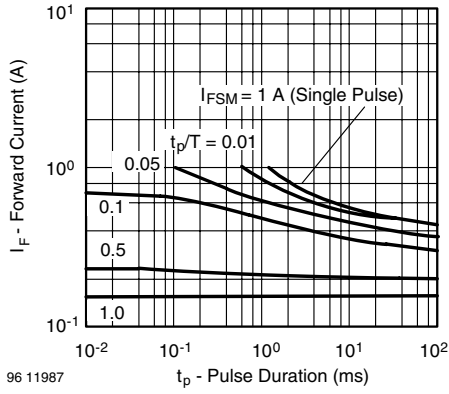
**BASIC CHARACTERISTICS**
 $T_{amb} = 25\text{ }^{\circ}\text{C}$ , unless otherwise specified


Fig. 3 - Pulse Forward Current vs. Pulse Duration

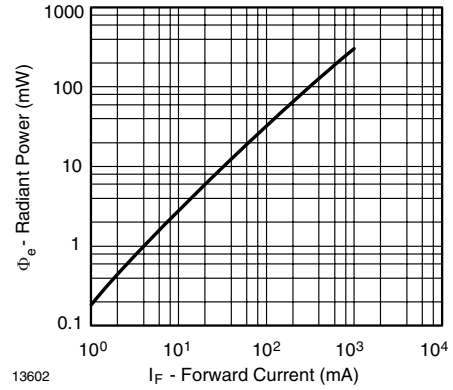


Fig. 6 - Radiant Power vs. Forward Current

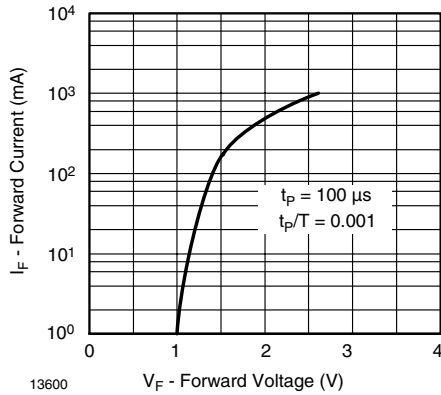


Fig. 4 - Forward Current vs. Forward Voltage

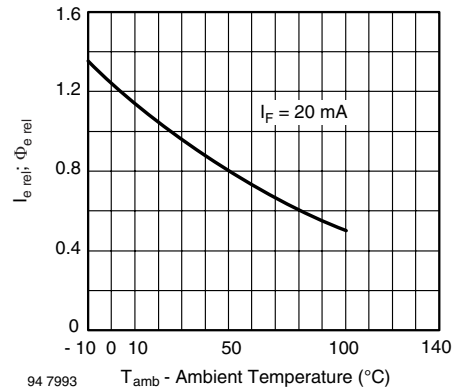


Fig. 7 - Relative Radiant Intensity/Power vs. Ambient Temperature

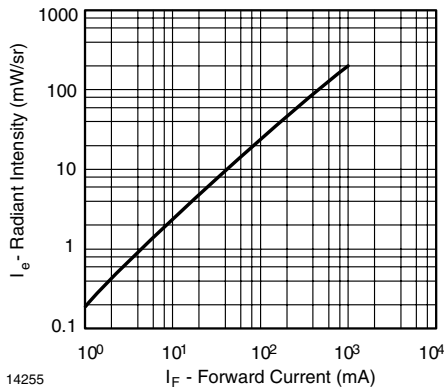


Fig. 5 - Radiant Intensity vs. Forward Current

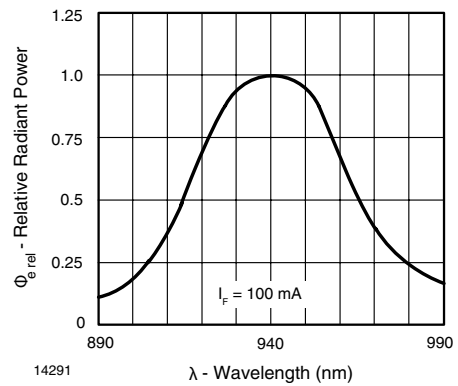


Fig. 8 - Relative Radiant Power vs. Wavelength

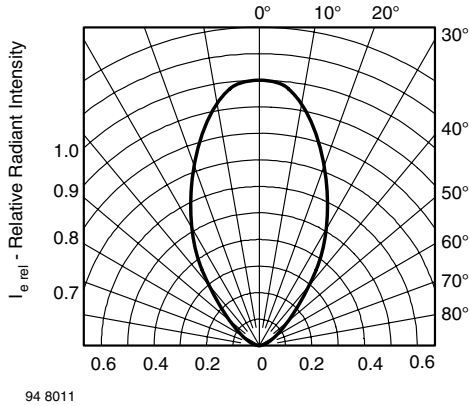
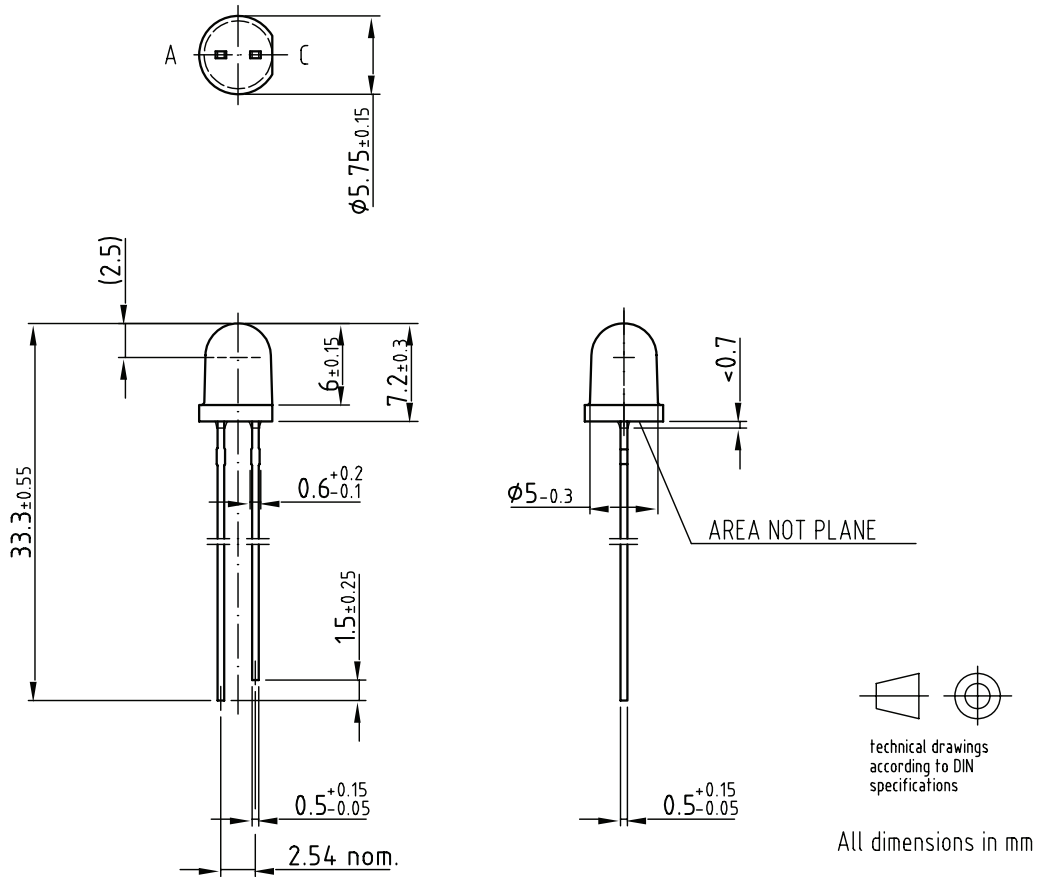


Fig. 9 - Relative Radiant Intensity vs. Angular Displacement

**PACKAGE DIMENSIONS** in millimeters



Drawing refers to following types: TSAL 7600

Drawing-No. 6.544-5316.01-4

Issue: 2; 27.09.04

20327



## Disclaimer

All product specifications and data are subject to change without notice.

Vishay Intertechnology, Inc., its affiliates, agents, and employees, and all persons acting on its or their behalf (collectively, "Vishay"), disclaim any and all liability for any errors, inaccuracies or incompleteness contained herein or in any other disclosure relating to any product.

Vishay disclaims any and all liability arising out of the use or application of any product described herein or of any information provided herein to the maximum extent permitted by law. The product specifications do not expand or otherwise modify Vishay's terms and conditions of purchase, including but not limited to the warranty expressed therein, which apply to these products.

No license, express or implied, by estoppel or otherwise, to any intellectual property rights is granted by this document or by any conduct of Vishay.

The products shown herein are not designed for use in medical, life-saving, or life-sustaining applications unless otherwise expressly indicated. Customers using or selling Vishay products not expressly indicated for use in such applications do so entirely at their own risk and agree to fully indemnify Vishay for any damages arising or resulting from such use or sale. Please contact authorized Vishay personnel to obtain written terms and conditions regarding products designed for such applications.

Product names and markings noted herein may be trademarks of their respective owners.